



Installation instructions

Torridon[®]
shower tray
for 3-wall installations

Contents

Timber Floor Installation
Solid Floor Installation

Page 3

Page 11



Before installation please check:

All component parts of your assembly, including fixings, are present and in good condition. Any shortages or damaged goods should be reported immediately.

The shower unit has a suitable flow rate. Power showers are not suitable for special needs trays and wet floors. (Note: Mixer valve showers may require a regulator should the flow rate exceed 9ltr/min).

Adaptocare recommend using cardboard packaging to protect tray surface from damage during installation.

Tools Required:

1. Ragging Saw
2. Hand Saw
3. Pozi-Screwdriver
4. Spirit Level
5. Tape Measure
6. Pencil
7. Silicone



Timber Floor Installation:

For recessed solid floor installation please see page 11

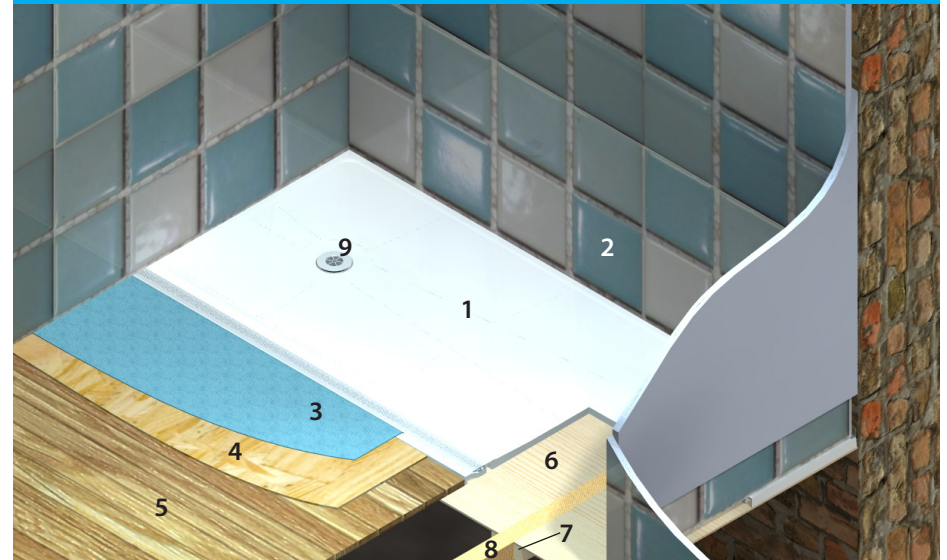

1. Torridon Tray
2. Tiled wall
3. Vinyl flooring
4. 6mm ply
5. Timber floor
6. Sheeting
7. Dwargs
8. Joists
9. Waste Trap

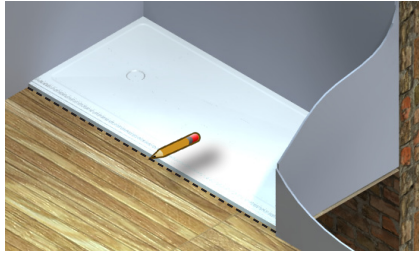

1. Remove any skirting boards and clear area ready for installation. Carefully position tray and mark perimeter on the floor.

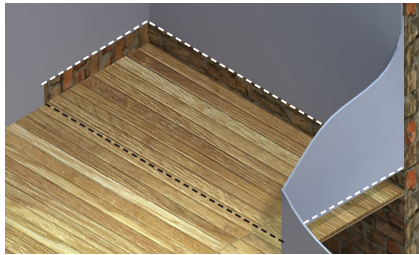

2. Using a raggling saw, chase out the wall inside the marked area to accomodate the tiling upstand. (The tiling upstand will recess approximately 5mm.)

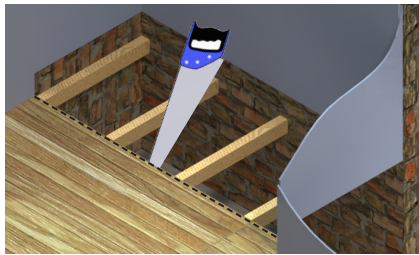

3. Using a suitable hand saw, cut and remove the floorboards along the perimeter line. Identify the existing waste outlet and plan the waste route.

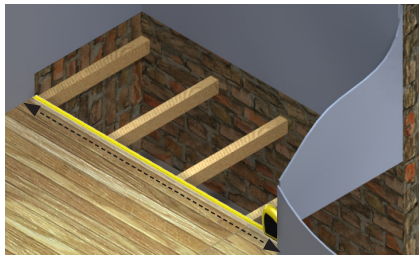

4. Carefully measure the wall to wall size to confirm the length of tray required. (When calculating the tray cutting size please allow a 5mm gap at each end for the tiling upstands)

Please Note: It is essential to measure both the front and back area as the walls may not be square.

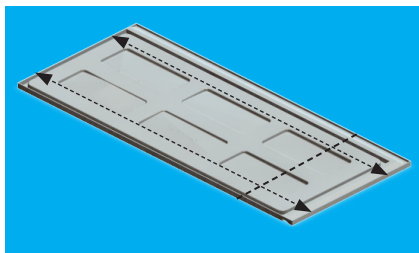

5. Mark the front and back measurements onto the tray and use a straight edge to carefully draw a guide line between them.

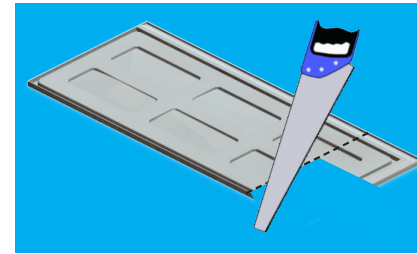

6. With the tray securely placed on a trestle, carefully cut along the guide line using a hand saw.

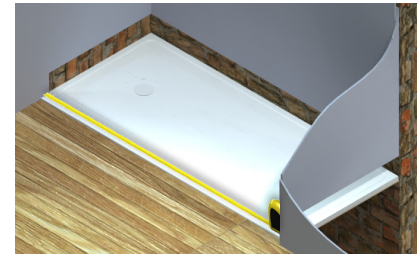

7. Having cut the tray to length, re-position the tray into the raggled wall to ensure accurate cut length and a good fit with space for the tiling upstands. Use a short rule or spirit level to ensure the tray is flush with the walls.

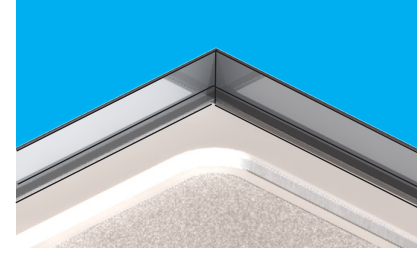

8. Align the attachable upstands on the edge of the tray ensuring the mitred ends create a flush join at the corner of installation.

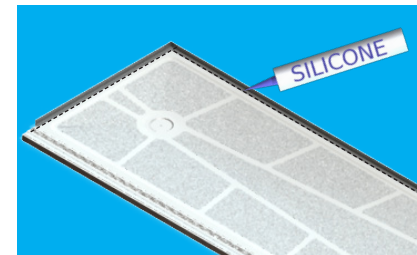

9. Apply a fine bead of silicone between the tiling lip of the upstand and the tray. Repeat this with the second and third upstand.

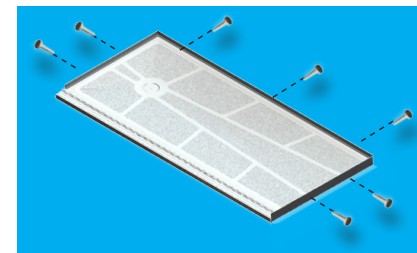

10. Using the grooved channel, drill through the back of the upstands into the tray and fit 3 of the 4mm pozi-drive screws supplied onto the long side and 2 onto each of the short sides.



11. Re-position the tray into the ragged wall, ensuring a good fit. Use a short rule or spirit level to ensure the tray is flush with the wall.

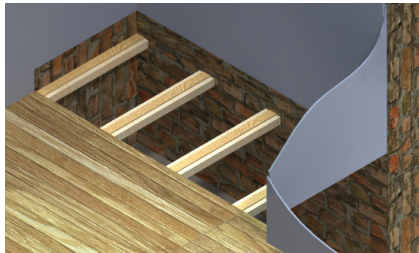

12. **Adaptocare** strongly advises dswanging and sheeting between the joists with a suitable product (E.g. ply or marine ply). This will provide a stable base and bedding platform for the tray. This must be done carefully to ensure levels are maintained.

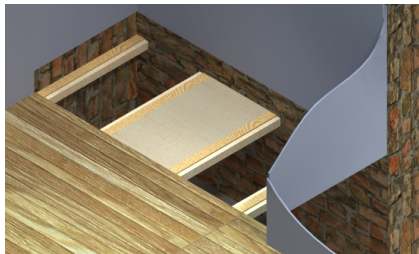

13. Firstly, cut the batons to length and then secure to joists relative to thickness of sheeting material.

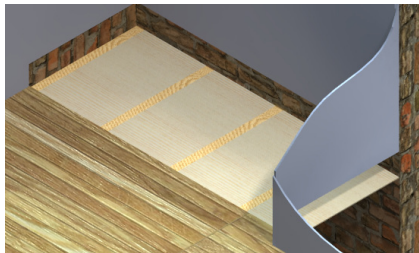

14. Place sheeting on the baton supports to ensure sheets sit flush and level with the joists. Once you are sure of the levels, secure sheets in place using suitable screws.

Please Note: It is important to check that the tray is level at different stages throughout the installation.



15. Using a pencil, mark the waste position of the tray onto the sheeting.

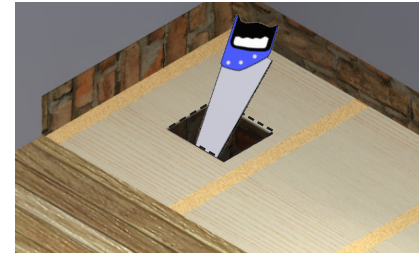

16. Cut a clearance hole into the ply sheeting for the McAlpine trap supplied.

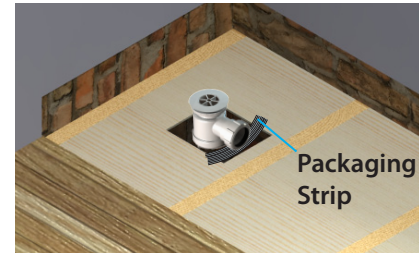

17. Secure the trap in position using the banding tape from the packaging positioned between the support batons.



18. Re-position the tray and ensure the trap aligns with the waste position on the tray, also checking the levels prior to bedding process. Adjust if necessary.

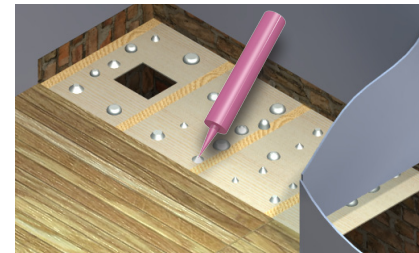

19. Bedding down the tray: Adaptocare's new generation of self-supporting trays only require a slight bedding to bond the tray to its platform.

Please note: As there should be no large voids to fill in the bedding process we do not recommend the use of expanding foam. Pink Grip, No Nails or other similar adhesive should suffice.

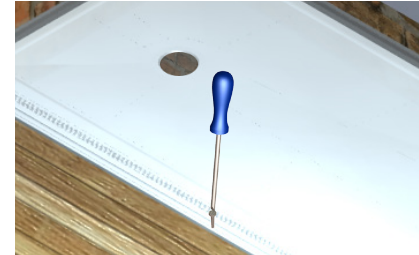

20. Using the countersunk holes located on the outside perimeter, and the timber screws provided, anchor the base to the batons/joist.



21. Fit the waste flange and check levels prior to leaving tray for curing - **check level again** with load applied.

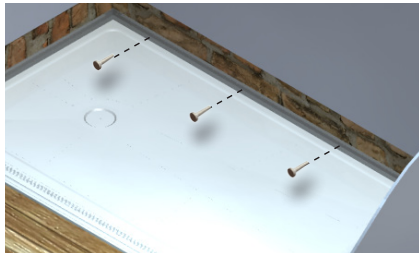

22. Using the grooved channel, drill through the front of the upstands into the wall and fit 3 of the 4mm pozi-drive screws onto the long side and 2 onto each of the short sides.

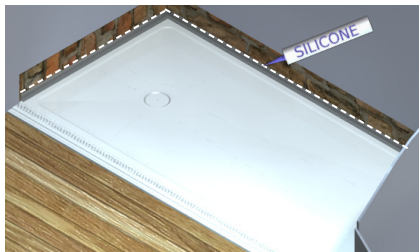

23. With the tray finally positioned, seal the tray to the walls using a silicone sealant **before** any tiles are applied to the walls.



24. As preparation for laying slip-resistant flooring, sheet the area surrounding the tray with 6mm ply to bring the floor to the level of the tray.

Please Note: When laying the flooring, cut approximately 18mm overlay from the front edge of the extrusion to allow flooring to slot between the aluminium extrusion and tray.

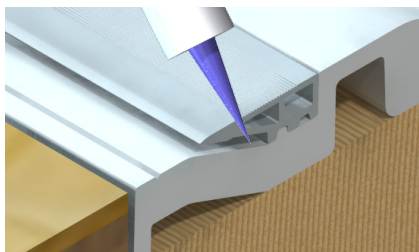

25. Using the silicone supplied, inject a generous amount into the slot and bond extrusion to ensure the vinyl is held captive when cured.

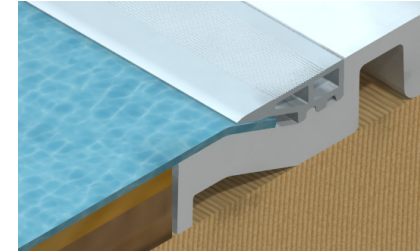

26. Gently push the flooring into the slot. This guarantees a unique seal between the flooring and the tray.

Please note: the largest vinyl thickness that the Torridon can accommodate is 3mm. However, it should be noted that most common vinyl flooring is only 2-2.5mm thick.



27. Fit the required tiles or wall panels, ensuring a level mounting is created at the outer corners for door installation if required.



28. To finish installation, a fine bead of silicone should be applied around the edge of the tray between the flooring and the tray

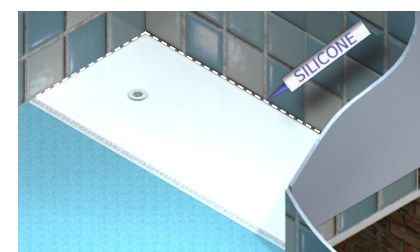

29. Finally, if wall panels are used, ensure that they are resting on the tray in front of the ragged upstand and have been sealed along their length with silicone.



Solid Floor Installation:



1. Torridon Tray
2. Tiled wall
3. Vinyl flooring
4. 6mm ply
5. Concrete floor
6. Waste Trap

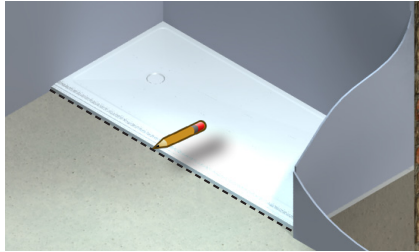

1. Remove any skirting boards and clear area ready for installation. Carefully position tray and mark perimeter on the floor.

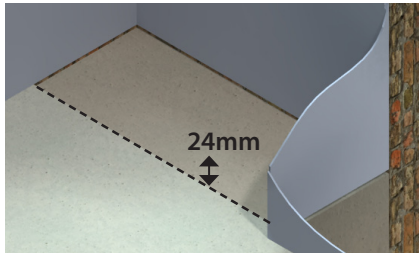

2. Using this line, excavate screed to an approximate depth of 24mm to accommodate the shower tray. (The tray should sit almost flush after laying the vinyl floor and 6mm ply.)

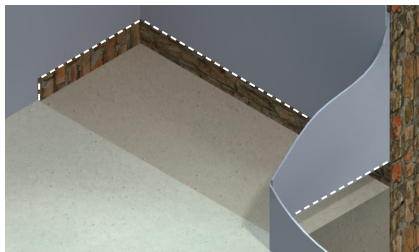

3. Using a ragging saw, chase out the wall inside the marked area to accommodate the tiling upstand. (The tiling upstand will recess approximately 5mm.)

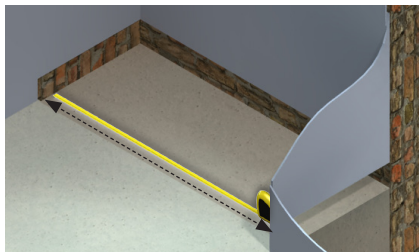

4. Carefully measure the wall to wall size to confirm the length of tray required. (When calculating the tray cutting size please allow a 5mm gap at each end for the tiling upstands)

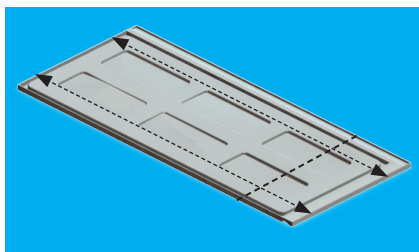

5. Mark the front and back measurements onto the tray and use a straight edge to carefully draw a guide line between them.

Please Note: It is essential to measure both the front and back area as the walls may not be square.

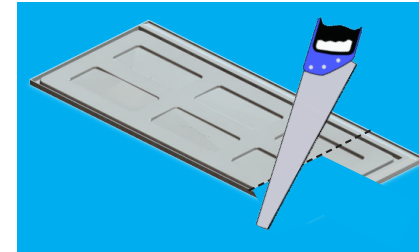

6. With the tray securely placed on a trestle, carefully cut along the guide line using a suitable hand saw.

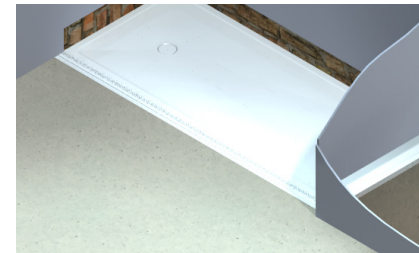

7. Having cut the tray to length, re-position the tray into the ragged wall to ensure accurate cut length and a good fit with space for the tiling upstands. Use a short rule or spirit level to ensure the tray is flush with the walls.

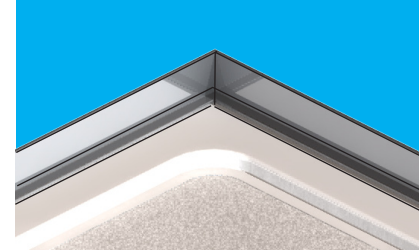

8. Align the attachable upstands on the edge of the tray ensuring the mitred ends create a flush joint at the corner of installation.

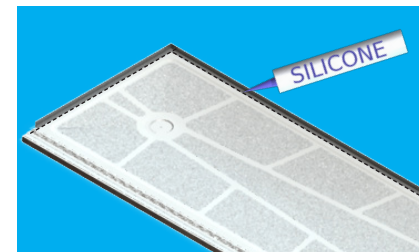

9. Apply a fine bead of silicone between the tiling lip of the upstand and the tray. Repeat this with the second and third upstand.

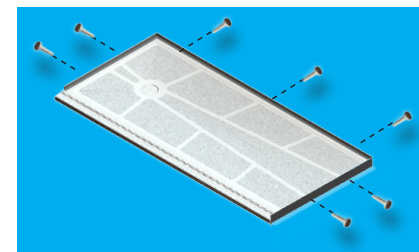

10. Using the grooved channel, drill through the back of the upstands into the tray and fit 3 of the 4mm pozi-drive screws supplied onto the long side and 2 onto each of the short sides.



11. Re-position the tray into the ragged wall, ensuring a good fit. Use a short rule or spirit level to ensure the tray is flush with the wall.



12. Remember to check that tray is level at different stages throughout the installation.

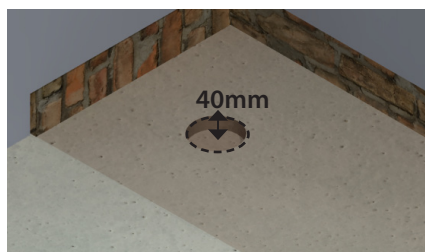

13. For pumped shower drainage; excavate a small bowl in the screeded floor, approximately 40mm deep by 150mm diameter to house the shower waste pump gully.



14. Some minor excavation will also be required for the 15mm waste pipe.

Please Note: Should a gravity waste be preferred over a shower waste pump, further excavation will be necessary to accommodate the larger trap and waste kit. A larger route will also be required for the 40mm waste pipe.



15. Bedding down the tray: For solid floors, bed the tray down using a 6mm layer of a weak sand and cement mix or thistle plaster.



16. Fit the waste flange and check levels prior to leaving tray for curing - **check level again** with load applied.

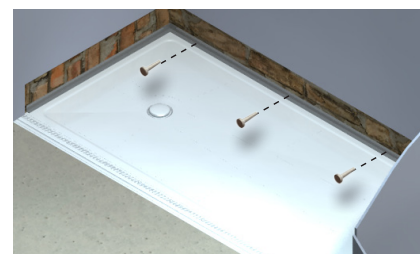

17. Using the grooved channel, drill through the front of the upstands into the wall and fit 3 of the 4mm pozi-drive screws onto the long side and 2 onto each of the short sides.



18. With the tray finally positioned, seal the tray to the walls using a silicone sealant **before** any tiles are applied to the walls.

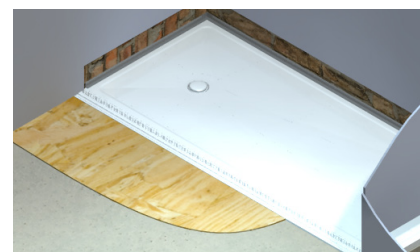

19. As preparation for laying slip-resistant flooring, sheet the area surrounding the tray with 6mm ply to bring the floor to the level of the tray.

Please Note: When laying the flooring, cut approximately 18mm overlay from the front edge of the extrusion to allow flooring to slot between the aluminium extrusion and tray.

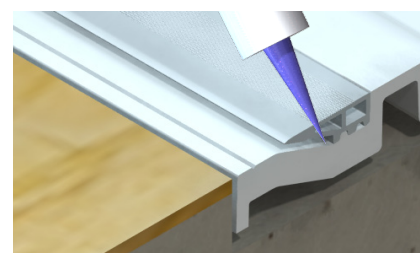

20. Using the silicone supplied, inject a generous amount into the slot and bond extrusion to ensure the vinyl is held captive when cured.

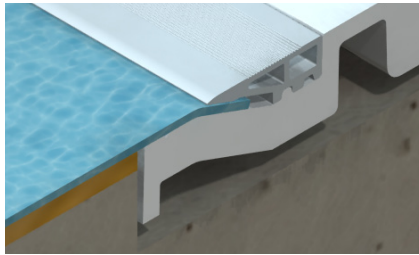

21. Gently push the flooring into the slot. This guarantees a unique seal between the flooring and the tray.

Please note: the largest vinyl thickness that the Torridon can accommodate is 3mm. However, it should be noted that most common vinyl flooring is only 2-2.5mm thick.



22. Fit the required tiles or wall panels, ensuring a level mounting is created at the outer corners for door installation if required.



23. To finish installation, a fine bead of silicone should be applied around the edge of the tray between the flooring and the tray.



24. Finally, if wall panels are used, ensure that they are resting on the tray in front of the ragged upstand and have been sealed along their length with silicone.

Waste Systems

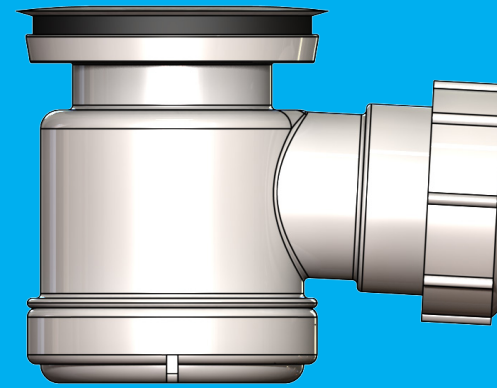

Adaptocare Standard Trap (STW5-R)

Our standard trap comes supplied with all of our Easy Access and Level Access shower trays. A clearance of **95mm** below the installed shower tray is required for use of this trap.

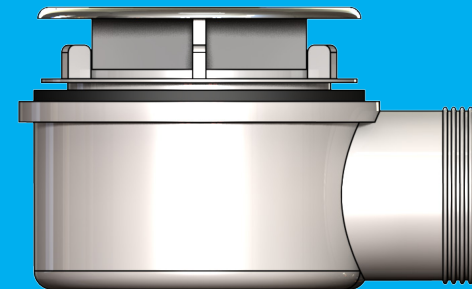

Adaptocare Shallow Trap (ST70SS85)

In instances when there is not enough clearance available for our standard trap, we can supply our shallow trap. A clearance of **50mm** below the installed shower tray is required for use of this trap.

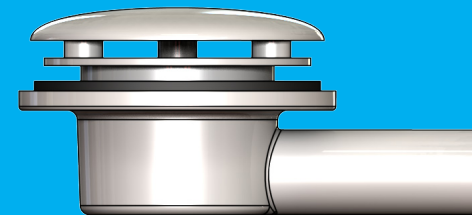

Pumped Waste Gully

For situations where a shallow trap will not suffice, we would recommend the use of one of our pumped waste systems. A clearance of **32mm** below the installed shower tray is required for use of this trap.

Adaptocare Limited

244 Nuneaton Street

Glasgow

G40 3DX

t: 0141 550 4177

info@adaptocare.co.uk

www.adaptocare.co.uk